



DOREL FRANCE S.A.S.
Z.I. - 9 bd du Poitou
BP 905
49309 Cholet Cedex
FRANCE

DOREL BENELUX
P.O. Box 6071
5700 ET Helmond
NEDERLAND

DOREL UK Ltd.
2nd Floor, Building 4
Imperial Place
Maxwell Road
Borehamwood, Herts
WD6 1JN
UNITED KINGDOM

DOREL GERMANY GMBH
Augustinusstraße 9 c
D-50226 Frechen-Königsdorf
DEUTSCHLAND

DOREL ITALIA S.P.A.
Via Verdi, 14
24060 Telgate (BG)
ITALIA

DOREL HISPANIA S.A.U.
Edificio Barcelona Moda Centre
Ronda Maiols, 1
Planta 4ª,
Locales 401 - 403 - 405
08192 Sant Quirze del Vallès
ESPAÑA

DOREL PORTUGAL
Rua Pedro Dias, 25
4480-614 Rio Mau (VDC)
PORTUGAL

DOREL JUVENILE
SWITZERLAND S.A.
Chemin de la Colice 4
1023 Crissier
SWITZERLAND / SUISSE

DOREL POLSKA Sp. z o.o.
Innowacyjna 8
41-208 Sosnowiec
POLAND

014802301

EN Non-contractual photos FR Photos non contractuelles ES Fotografías no contractuales IT Foto non contrattuali PT Fotografias não contractuais RU Фотография может отличаться от товара TR Fotoğraflar bağlayıcı değildir AR صور غير تعاقبية



AxissFix Air

61 cm-105 cm / max 19 kg



EN Congratulations on your purchase.

For the maximum protection and comfort of your child, it is essential that you read through the entire manual carefully and follow all instructions.

FR Nous vous félicitons pour votre achat.

Pour une protection maximale et un confort optimal de votre bébé, il est essentiel de lire attentivement et intégralement le mode d'emploi et de respecter les instructions.

ES Enhorabuena por su compra.

Para ofrecer la máxima protección y un óptimo confort para su bebé es muy importante que lea el manual atentamente y siga las instrucciones de uso.

IT Congratulazioni per il tuo acquisto.

Per la massima protezione e per un confort ottimale del tuo bambino è molto importante leggere e seguire attentamente tutte le istruzioni.

PT Felicitámo-lo pela sua compra.

Para máxima proteção e conforto para o seu bebé, é importante que leia atentamente e siga todas as instruções de utilização.

RU Поздравляем Вас с покупкой.

Для максимальной защиты и комфорта вашего ребенка важно прочитать всю инструкцию и следовать всем рекомендациям.

TR Satın aldığınız bu ürün için sizi tebrik ederiz.

Çocuğunuza maksimum koruma ve ideal konforu sağlamak için, tüm kılavuzu dikkatlice okumanız ve tüm talimatlara uymanız şarttır.

AR

نهنك على شرائك هذا المنتج.

لتمين أقصى حماية وراحة لطفلك، من الأساسي أن تقوم بقراءة الدليل بأكمله بانتباه واتباع كافة التعليمات.



INDEX

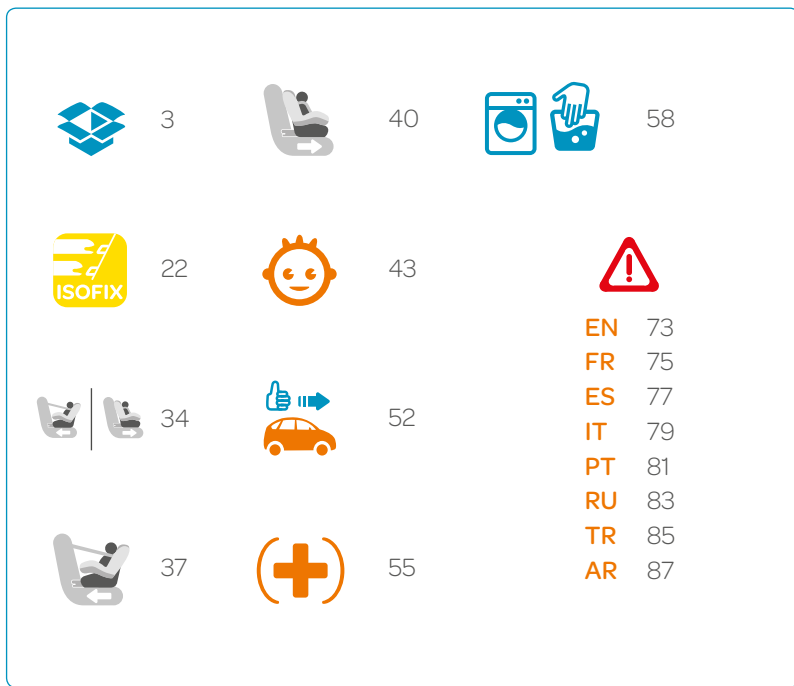



EN

AxissFix Air is the first car seat with integrated Airbag that complies with the new European regulation i-size R129, active from July 2013. i-Size aims at increasing children safety in car by promoting UNIVERSAL ISOFIX installation, by supporting rearward-facing travel up to minimum 15 months, by improving protection for head and neck. To learn more on i-Size, please connect on the website www.bebeconfort.com

FR

AxissFix Air est le premier siège auto avec la fonction Airbag intégrée qui répond à la nouvelle réglementation Européenne i-Size R129, effective depuis juillet 2013. L'i-Size vise à améliorer la sécurité des enfants en voiture en imposant le système ISOFIX UNIVERSEL, en rendant la position dos à la route obligatoire jusqu'à 15 mois minimum et en améliorant la protection de la tête et du cou de l'enfant. Pour en savoir plus sur l'i-Size, connectez-vous sur le site internet www.bebeconfort.com

ES

AxissFix Air es la primera silla de auto con Airbag integrado que cumple con la nueva normativa europea i-Size R129, activa desde julio de 2013. i-Size se ha concebido para mejorar la seguridad de los niños que van en coche gracias a la instalación del sistema UNIVERSAL ISOFIX, que obliga a su colocación en el sentido contrario a la marcha para los niños menores de 15 meses y mejora la protección de la cabeza y el cuello. Para más información acerca de i-Size, visite el sitio web www.bebeconfort.com

IT

AxissFix Air è il primo sedile auto con airbag integrato conforme alla nuova normativa europea i-size R129, attiva dal luglio 2013. i-Size mira ad aumentare la sicurezza dei bambini in macchina promuovendo l'installazione con ISOFIX UNIVERSALE, rendendo possibile l'installazione in senso contrario di marcia fino ad un minimo di 15 mesi e migliorando la protezione per testa e collo. Per maggiori informazioni su i-Size, collegarsi al sito www.bebeconfort.com



PT

A AxissFix Air é a primeira cadeira-auto com airbag integrado que cumpre com a mais recente legislação europeia i-Size R129, ativa desde Julho 2013. O i-Size tem por objectivo aumentar a segurança das crianças nos automóveis incentivando a instalação do UNIVERSAL ISOFIX, encorajando a posição do bebé virado para trás até, no mínimo, os 15 meses, e melhorando a protecção para a cabeça e o pescoço. Para saber mais sobre a norma i-Size, visite o endereço web www.bebeconfort.com

RU

AxissFix Air – первое автомобильное сиденье со встроенной подушкой безопасности, которое соответствует новому европейскому стандарту i-размера R129, действующему с июля 2013 года. Стандарты i-Size направлены на повышение безопасности детей в автомобиле путем стимулирования повсеместной установки систем ISOFIX, введения общего правила перевозки детей в положении лицом назад до возраста как минимум 15 месяцев для лучшей защиты головы и шеи. Чтобы узнать больше о нормах i-Size, посетите наш сайт www.bebeconfort.com

TR

AxissFix Air, ürüne hava yastığı (air bag) entegre edilmiş ve 2013 yılı Temmuz ayından itibaren yürürlükte olan yeni Avrupa standardı i-Size R129'a uygun ilk oto güvenlik koltuğudur. i-Size UNIVERSAL ISOFIX bağlantısını teşvik ederek, minimum 15 aya kadar sürüş yönünün tersine seyehati destekleyerek, kafa ve boyun korumasını iyileştirerek araç içinde çocuk emniyetini arttırmayı amaçlamaktadır. i-Size hakkında daha fazla bilgi için, lütfen www.bebeconfort.com internet sitesini ziyaret edin

AR

أكسيسفكس إير هو أول مقعد سيارة مع وسادة هوائية متكاملة تتوافق مع اللائحة الأوروبية الجديدة -إسيز R129، النشطة اعتباراً من يوليو 2013. تهدف الـ i-Size إلى الزيادة من سلامة الأطفال داخل السيارة من خلال التشجيع على تثبيت الـ ISOFIX العالمي، ودعم السفر في الوضعية المواجهة للخلف حتى بلوغ الـ 15 شهراً على الأقل و التحسين من حماية الرأس و الرقبة. لقراءة المزيد عن الـ i-Size، يرجى زيارة الموقع: www.bebeconfort.com

EN

• Does AxissFix Air fit your car?

AxissFix Air is an i-Size (R 129) Child Restraint System. It is approved to Regulation No. 129 and fits in most vehicles equipped with ISOFIX, and on all i-Size compatible vehicle seating positions.

This car seat is installed by connecting the two ISOFIX connectors and webbing "TOP TETHER" in the anchorage ISOFIX points of the vehicle.

• AxissFix Air ISOFIX system gives you:

Easier and quicker installation: without a seat belt going through it. Reinforced safety: fixed to vehicle's chassis for a better restraint in the event of impact and triple visual indicators to ensure a correct installation.



FR

• AxissFix Air est-il compatible avec votre voiture ?

AxissFix Air est un dispositif de retenue pour enfant i-Size (R 129). Il est approuvé selon le règlement N°129 et convient à la plupart des véhicules équipés du dispositif ISOFIX et à tous les véhicules compatibles avec le dispositif i-Size.

Ce siège auto s'installe en connectant les 2 pinces ISOFIX et la sangle "TOP TETHER" aux points d'ancrages ISOFIX du véhicule.

• Le système ISOFIX AxissFix Air vous garantit :

Une installation Plus simple et Plus rapide : sans ceinture de sécurité qui le traverse. Une sécurité renforcée: le siège est fixé à l'habitacle du véhicule pour une meilleure retenue en cas d'impact et une triple indication visuelle pour s'assurer de la correcte installation.



ES

• ¿AxissFix Air es compatible con su vehículo?

AxissFix Air es un dispositivo de sujeción para niños i-Size (R 129). Cuenta con la homologación de la Norma N°129 y se puede adaptar a la mayoría de los vehículos que cuenten con dispositivo ISOFIX y a todos los vehículos compatibles con el dispositivo i-Size.

Para instalar esta silla de coche se conectan las dos pinzas ISOFIX y la correa "TOP TETHER" a los puntos de anclaje ISOFIX del vehículo.

• El sistema ISOFIX AxissFix Air garantiza:

Una instalación más sencilla y rápida: sin cinturón de seguridad que atraviese la silla de auto. Una mayor seguridad: la silla de auto está fijada al chasis del vehículo para mayor sujeción en caso de impacto y una triple indicación visual para asegurarse de que la instalación se ha realizado **correctamente**.



IT

• AxissFix Air è adatto alla tua auto?

AxissFix Air è un dispositivo di ritenuta per bambini i-Size (R 129). Esso è conforme alla normativa europea n. 129 e si adatta alla maggior parte dei veicoli dotati del dispositivo ISOFIX e a tutti i veicoli compatibili con il dispositivo i-Size.

Questo seggiolino auto si installa collegando le 2 pinze ISOFIX e la cinghia "TOP TETHER" ai punti di fissaggio ISOFIX del veicolo.

• Il sistema ISOFIX AxissFix Air vi garantisce:

Un'installazione più semplice e più rapida, senza bisogno di utilizzare la cintura di sicurezza dell'auto. Una sicurezza rinforzata: il seggiolino è fissato al telaio del veicolo per una migliore ritenuta in caso d'impatto ed è dotato di 3 indicatori visivi per assicurarsi della corretta installazione.

PT

• A AxissFix Air é adequada ao seu automóvel?

AxissFix Air é um dispositivo de retenção para criança i-Size (R 129). Está aprovado segundo a Norma n.º 129 e é adequado à maior parte dos veículos equipados com o dispositivo ISOFIX e a todos os veículos compatíveis com o dispositivo i-Size.

Esta cadeira-auto instala-se fixando os 2 conetores ISOFIX e a correia "TOP TETHER" aos pontos de fixação ISOFIX do veículo.

• O sistema ISOFIX da AxissFix Air garante:

Uma instalação mais simples e mais rápida da cadeira, sem necessidade de utilizar o cinto de segurança do automóvel para a prender. Uma segurança reforçada, a cadeira é fixa ao chassis do veículo para uma melhor retenção em caso de impacto e a confirmação visual tripla assegura a correta instalação.

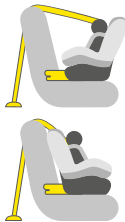

RU

• Подходит ли кресло AxissFix Air для вашего автомобиля?

Детское автокресло AxissFix Air является системой безопасности в соответствии со стандартом i-Size (R 129). Оно прошло испытания согласно Постановлению №129 и подходит для большинства автомобилей, оснащенных системой креплений ISOFIX, а также для всех сидений, совместимых с автокреслами стандарта i-Size.

Это автокресло устанавливается путем защелкивания двух зажимов ISOFIX и фиксирующего ремня «TOP TETHER» в точках крепления ISOFIX в автомобиле.

• Преимущества AxissFix Air и системы ISOFIX:

Простая и быстрая установка – не нужно продевать ремень безопасности. Улучшенная безопасность – автокресло надежнее крепится к конструкции автомобиля, обеспечивая лучшее удержание в случае удара, оно оснащено тремя визуальными индикаторами для обеспечения правильной установки.

TR

• AxissFix Air aracınıza uyar mı?

AxissFix Air (R 129) bir Çocuk Emniyet Sistemidir. Yönetmelik No. 129'a uygundur ve ISOFIX ile donatılmış çoğu araca ve i-Size ile uyumlu araç oturma Çocuk koltuğu, iki ISOFIX bağlantısı ve "TOP TETHER" kemer kayışı aracın ISOFIX noktalarına bağlanarak monte edilir.



Çocuk koltuğu, iki ISOFIX bağlantısı ve "TOP TETHER" kemer kayışı aracın ISOFIX noktalarına bağlanarak monte edilir.

• AxissFix Air ISOFIX sistemi size şunları sağlar:

Daha kolay ve daha hızlı kurulum: bir emniyet kemeri geçirmeden. Güçlendirilmiş güvenlik: darbe durumunda daha fazla emniyet için aracın şasisine sabitlenmiştir ve doğru şekilde montaj için üçlü görsel göstergelere sahiptir.



AR

• هل الـ AxissFix Air متوافق مع سيارتك :

الـ AxissFix Air هو جهاز لتقييد حركة الأطفال (i-Size R 129).

تمت المصادقة عليه حسب القانون رقم 129 كما يلائم جميع السيارات المجهزة بأداة الـ ISOFIX والسيارات المتوافقة مع أداة الـ i-Size. هذه القائمة من السيارات المتوافقة هي قائمة غير حصرية

يتم تثبيت مقعد السيارة هذا عن طريق ربط الوصلات ISOFIX و حزام "TOP TETHER" بنقاط التثبيت ISOFIX بالسيارة.

• يضمن لكم نظام AxissFix Air:

تثبيت أسهل وأسرع: دون حزام أمان يمزّ عبه. أمان مضاعف: المقعد مثبت على مقصورة ركّاب السيارة من أجل تقييد حركة أمتل في حالة تصادم إلى جانب إشارة مرئية ثلاثية لضمان التثبيت الصحيح.

EN

ATTENTION:

- In rear-facing position (61-87 cm), this product must not be installed to places equipped with a frontal airbag. You might be able to deactivate it (see your car manual). In this case, if you can deactivate the airbag, you can use the car seat on the front seat.
 - In forward facing position (76-105 cm), the seat must be placed on the car rear seat or exceptionally on the front seat in accordance with the legislation in force in the country of use (In France: in accordance with the conditions stipulated in decree n°91-1321 du 27-12-1991).
- If you use the AxissFix Air on the front seat, it should be possible to deactivate the airbag of the seat in question or move the passenger seat back to a maximum (Please consult your car manual).

This child restraint is classified for “Universal” use and is suitable for fixing into the seat position of the following cars:

Car	Front passenger (outer)	Rear left/right (outer)	Rear centre
Volkswagen Golf 7			

IMPORTANT:

For a complete list of cars, please visit www.bebeconfort.com/car-fitting-list

Seat positions in other cars may also be suitable to accept this child restraint. If in doubt, consult either the child restraint manufacturer or the retailer.



FR

ATTENTION:

- En position dos à la route (61-87 cm), ce produit ne doit pas être installé aux places équipées d'un coussin gonflable airbag frontal. Vous avez peut-être la possibilité de le désactiver (voir notice fournie avec votre véhicule). Dans ce cas, si vous pouvez désactiver l'airbag, vous pouvez l'utiliser à l'avant de votre véhicule.
- En position face à la route (76-105 cm), le siège doit être placé sur la banquette arrière du véhicule ou exceptionnellement à l'avant selon la législation en vigueur dans le pays d'utilisation. (En France : selon les conditions énoncées dans le décret n°91-1321 du 27-12-1991). Si vous utilisez l'AxissFix Air sur le siège passager avant, il est possible de devoir désactiver l'airbag du siège en question ou placez le siège passager dans la position la plus reculée. (Veuillez consulter la notice d'utilisation de votre véhicule).

Ce dispositif de retenue pour enfants appartient à la catégorie "Universe1" et peut-être installé aux places assises des véhicules suivants :

Voiture	Passager avant (extérieur)	Arrière gauche/droite (extérieur)	Siège central arrière
Volkswagen Golf 7			

IMPORTANT :

Pour obtenir une liste complète des véhicules, rendez-vous sur www.bebeconfort.com/car-fitting-list

D'autres positions de sièges dans d'autres véhicules peuvent convenir. En cas de doute, veuillez consulter le distributeur ou le fabricant du système de retenue pour enfants.

ES

ATENÇÃO:

- En posición de espaldas a la carretera (61-87 cm), este producto no debe instalarse en plazas equipadas con un airbag frontal. Es posible que pueda desactivar este airbag (consulte el manual que se entrega con el vehículo). En este caso, sí puede utilizarlo en el asiento delantero del vehículo.
- En posición de cara a la carretera (76-105 cm), la silla de auto debe colocarse en el asiento trasero del vehículo o, excepcionalmente, en el delantero si lo permite la legislación vigente en el país. (En Francia: según las condiciones establecidas en el decreto n°91-1321 del 27-12-1991). Si utiliza AxissFix Air en el asiento delantero del copiloto, es posible que deba desactivar el airbag de ese asiento o bien situar el asiento en la posición más atrasada posible (Consulte el manual de instrucciones de su vehículo).

Este sistema de retención infantil está clasificado de uso "Universal" y es apto para fijar en el asiento de los siguientes automóviles:

Coche	Asiento del copiloto	Asiento trasero izquierdo/derecho	Asiento trasero central
Volkswagen Golf 7			

IMPORTANTE:

Para ver un listado completo de automóviles, visite www.bebecomfort.com/car-fitting-list

Hay coches que pueden permitir la instalación de la silla en otras posiciones. Si tienes dudas, consulta con el fabricante de la silla o con tu tienda especializada.



IT

ATTENZIONE:

- In posizione contraria al senso di marcia (61-87 cm), questo prodotto non deve essere posizionato nei posti provvisti di airbag frontale, a meno che quest'ultimo possa essere disattivato (consultate il manuale della vostra auto). In questo caso, se potete disattivare l'airbag, potete utilizzarlo sui sedili anteriori della vostra auto.
- Se installato nel senso di marcia (76-105 cm), il seggiolino deve essere posizionato sul sedile posteriore dell'auto o eccezionalmente sul sedile anteriore, a seconda della legislazione in vigore nel paese di utilizzo. (in Francia: secondo le condizioni riportate nel decreto n°91-1321 del 27-12-1991). Se utilizzate AxissFix Air sul sedile anteriore, è possibile che dobbiate disattivare l'airbag del sedile in questione o che dobbiate posizionare il sedile del passeggero nella posizione più arretrata. (Consultate il manuale d'uso della vostra auto).

Questo dispositivo di ritenuta per bambini è classificato per l'uso "Universale" ed è adatto per il fissaggio sul sedile delle vetture seguenti:

Auto	Passeggero anteriore	Passeggero posteriore laterale	Passeggero posteriore centrale
Volkswagen Golf 7			

IMPORTANTE:

Per un elenco completo delle vetture, vetture compatibili, visitare il sito www.bebeconfort.com/car-fitting-list

Il seggiolino potrebbe anche essere utilizzato su altri sedili dell'automobile. In caso di dubbio consultare il manuale d'istruzioni dell'autovettura.



PT

ATENCIÓN:

- Na posição voltada para trás (61-87 cm), este produto não deve ser instalado nos locais equipados com um "Air-Bag" frontal. Poderá ter a possibilidade de o desactivar (consultar o manual fornecido com o veículo). Neste caso, se puder desativar o airbag, pode instalar a cadeira à frente, no seu veículo.
- Na posição voltada para a frente (76-105 cm), a cadeira deve ser colocada no banco de trás do veículo ou, excepcionalmente, à frente conforme a legislação em vigor no país de utilização. (em França: conforme as condições referidas no decreto 91-1321 de 27-12-1991). Se utilizar a AxissFix Air no banco dianteiro do passageiro, poderá ter de desactivar o airbag do banco em questão ou ter de colocar o banco do passageiro na posição mais recuada (consultar o manual de utilização do veículo).

Esta cadeira-auto possui um sistema "Universal", pelo que deve consultar a lista de automóveis compatíveis no website da marca:

Carro	FrentePassageiro (exterior)	FrentePassageiro (exterior)	Centro traseiro
Volkswagen Golf 7	✗	✓ / ✓	✗

IMPORTANTE:

Para uma lista completa dos automóveis, visite www.bebeconfort.com/car-fitting-list

As posições de instalação da cadeira podem variar noutros carros. Consulte sempre o fabricante ou o lojaista em caso de dúvida.

RU

ВНИМАНИЕ:

- Установка в положении лицом назад (61–87 см) на сиденьях, оборудованных фронтальной подушкой безопасности, запрещается. В некоторых автомобилях допускается деактивация подушки безопасности (см. руководство по эксплуатации автомобиля). В таком случае для установки автомобильного кресла на переднем сидении деактивируйте подушку безопасности.
- В положении лицом вперед (76–105 см) кресло следует устанавливать на заднем сидении или, в исключительных случаях, на переднем сидении в соответствии с законодательством страны, в которой используется кресло (во Франции: в соответствии с требованиями Указа № 91–1321 от 27.12.1991). При установке кресла AxissFix Air на переднем сидении должна быть возможность деактивировать подушку безопасности данного сидения или максимально отодвинуть пассажирское сиденье назад (см. руководство по эксплуатации автомобиля).

Это детское кресло классифицируется для использования как “универсальное” и подходит для крепления на сиденья следующих автомобилей:

Автомобиль	Фронт Пассажир (внешний)	Задний левый/ правый (внешний)	Задний центр
Volkswagen Golf 7			

ВАЖНО:

Полный список автомобилей доступен на www.bebeconfort.com/car-fitting-list

Расположение сиденья в других автомобилях также может быть пригодно для детского удерживающего устройства.

TR

DIKKAT:

- Bu ürün, hava yastığı önde olan yerlere sürüş yönünün tersine bakar konumda (61-87 cm) monte edilmemelidir. Hava yastığını devre dışı bırakabilirsiniz (araç kılavuzuna başvurun). Bu durumda, hava yastığını devre dışı bırakabiliyorsanız, çocuk koltuğunu ön koltukta kullanabilirsiniz.
- Sürüş yönüne bakar konumda (76-105 cm), çocuk oto güvenlik koltuğu aracın arka koltuğuna veya istisnai durumlarda, kullanıldığı ülkenin yasalarına uygun şekilde ön koltuğa yerleştirilmelidir (Fransa'da: 27.12.1991 tarihli, 91-1321 sayılı kanun hükümleri uyarınca). AxissFix Air'i ön koltukta kullanacaksanız, söz konusu koltuğun hava yastığının devre dışı bırakılabilmesi veya yolcu koltuğunun maksimum derecede geriye çekilebilir olması gerekmektedir (lütfen araç kılavuzuna başvurun).

Bu çocuk emniyet sistemi "Evrensel" kullanım için sınıflandırılmıştır ve aşağıdaki araçların koltuk pozisyonuna sabitlemek için uygundur:

Araba	Ön Yolcu (dış)	Arka sol/sağ (dış)	Arka orta
Volkswagen Golf 7	✘	✓ / ✓	✘

ÖNEMLİ:

Araçların tamamının listesi için lütfen www.bebeconfort.com/car-fitting-list adresini ziyaret ediniz.

Diğer arabalardaki oturma pozisyonları da bu çocuk güvenlik sistemi için uygun olabilir. Emin olmak için çocuk güvenlik sistemi üreticisi veya bayinize danışınız.

AR

تحذير:

- ثبت الـ AxisFix Air في وضعية مواجهة للخلف عندما يكون طول طفلك ما بين ٦١ و ٨٧ سنتيمترا.
- يمكنك تثبيت الـ AxisFix Air في وضعية مواجهة للأمام عندما يتراوح طول ابنك بين ٧٦ و ١٠٥ سنتيمتر (أكبر من ١٥ شهرا). كتلة الراكب القصوى التي صُمم مقعد السيارة لأجلها هي ١٩ كلغ.

أداة تثبيت الأطفال هذه مُصنّفة للاستعمال "شبه العالمي" و هي ملائمة لأن تُركَّب في وضع مقعد السيارات التالية:

سيارة	أمامي الراكب (الخارجي)	الخلفي يساريين (الخارجي)	مركز الخلفي
Volkswagen Golf 7	✗	✓ / ✓	✗

هام:

للحصول على القائمة الكاملة للسيارات يرجى زيارة:
www.bebeconfort.com/car-fitting-list

كيفية الجلوس و وضعية المقعد في سيارات أخرى قد تكون أيضا مناسبة لاستعمال مقعد السيارة للأطفال هذا. إذا كنت في شك، فاستشر.



EN

Consult the vehicle manual to find the location of ISOFIX anchorages and more information about installing the carseat in the vehicle.

FR

Consultez la notice du véhicule pour trouver l'emplacement des ancrages ISOFIX, et obtenir des informations complémentaires concernant l'installation du siège dans le véhicule.

ES

Consulte el manual del vehículo para localizar los anclajes ISOFIX y obtener más información sobre la instalación de la silla de auto en el vehículo.

IT

Consultare il manuale del veicolo per conoscere la posizione degli ancoraggi ISOFIX e ottenere maggiori informazioni sull'installazione del seggiolino nel veicolo.

PT

Consultar o manual do veículo para encontrar a localização dos conetores ISOFIX e obter informações complementares sobre a instalação da cadeira no veículo.

RU

Чтобы найти расположение креплений ISOFIX и более подробную информацию об установке сиденья в автомобиле, обратитесь к справочнику по эксплуатации транспортного средства.

TR

ISOFIX bağlantı noktalarının yerlerini bulmak ve araçtaki araç koltuğunun montajı ile ilgili daha fazla bilgi almak için araç kılavuzuna başvurun.

AR

راجع دليل السيارة للتعرف على أماكن نقاط تثبيت ISOFIX إلى جانب مزيد من المعلومات حول تثبيت مقعد الطفل في السيارة.

EN Instructions for use

FR Mode d'emploi

ES Instrucciones de uso

IT Istruzioni d'uso

PT Instruções de utilização

RU Инструкция по применению

TR Kullanım talimatları

AR تعليمات الإستعمال





EN ISOFIX

FR ISOFIX

ES ISOFIX

IT ISOFIX

PT ISOFIX

RU ISOFIX

TR ISOFIX

AR ISOFIX



www.bebeconfort.com



①



②

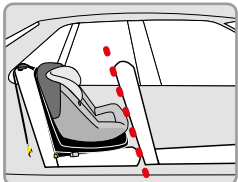

✗ NO

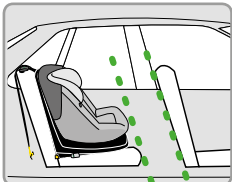

✓ OK



3



4



5

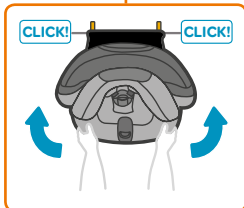

6



✗ NO



✓ OK



X2



7

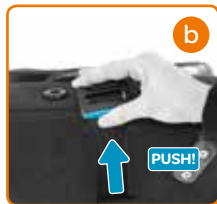

8



9

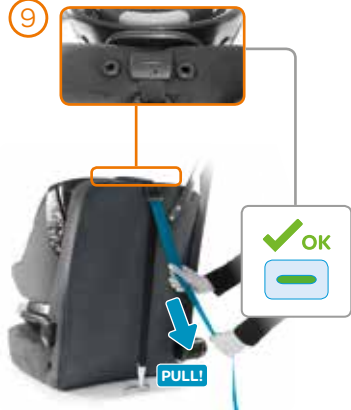

10

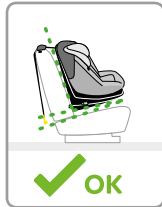



TOP TETHER



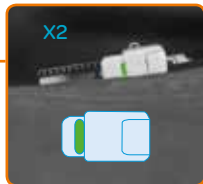





- EN Rearward facing position / Forward facing position
- FR Position dos route / Position face route
- ES Posición en el sentido contrario a la marcha / Posición en el sentido de la marcha
- IT In senso contrario di marcia / In senso di marcia
- PT Posição voltada para a retaguarda / Posição voltada para a frente
- RU Положение лицом назад / Положение лицом вперед
- TR Sürüş yönünün tersine dönük konum / Sürüş yönüne dönük konum
- AR تواجه الأمام موقف / موقف تواجه المؤخرة



www.bebeconfort.com



61-87 cm



76-105 cm



>15 m



EN

The car seat should be used rearward facing up to a minimum age of 15 months to guarantee optimum safety for your child. Bébé Confort recommends you use the seat in the backward-facing position for as long as possible and up to the limit shown (87 cm). This makes it possible to improve the protection of the head and neck of the infant, which is still very fragile at this age, very significantly.

FR

Le siège auto doit être utilisé jusqu'à minimum 15 mois dos à la route. Pour garantir une sécurité optimale de votre enfant, Bébé Confort vous recommande d'utiliser le siège en position dos à la route le plus longtemps possible et jusqu'à la limite indiquée (87 cm). Ceci permet d'améliorer très significativement la protection de la tête et du cou de l'enfant, encore très fragile à cet âge.

ES

El asiento debe usarse en posición contraria a la marcha, hasta al menos los 15 meses de edad para garantizar la máxima seguridad para su hijo. Bébé Confort le recomienda que utilice este asiento en el sentido contrario a la marcha durante el mayor tiempo posible y hasta la estatura indicada (87 cm). Esto permite mejorar significativamente la protección de la cabeza y el cuello del niño, que todavía son muy frágiles a esa edad.

IT

Il seggiolino deve essere usato in senso contrario di marcia fino ad minimo di 15 mesi per garantire la sicurezza del bambino. Bébé Confort consiglia di usare il seggiolino in posizione contraria al senso di marcia il più a lungo possibile e comunque fino al limite indicato (87 cm). Questo rende possibile migliorare la protezione della testa e del collo del bambino che sono ancora molto fragili a quell'età.



PT

A cadeira-auto deve ser usada com o bebé virado para trás até uma idade mínima de 15 meses para garantir a segurança ideal da criança. A Bébé Confort recomenda que use a cadeira na posição de costas para a estrada durante o tempo máximo possível e até ao limite referido (87 cm). Isto permite melhorar de forma significativa a protecção da cabeça e do pescoço da criança, que ainda é muito frágil nesta idade.

RU

Sedačka by mala byť použitá proti smeru jazdy až do veku minimálne 15 mesiacov , aby bola zaručená optimálna bezpečnosť vášho dieťaťa . Bébé Confort odporúča používať sedačku dozadu obrátenej polohy as dlho , ako je to možné , a až do limitu , znázornenej (87 cm) . Vďaka tomu je možné zlepšiť ochranu hlavy a krku dieťaťa , ktorý je stále veľmi krehká v tomto veku , veľmi výrazne .

TR

Çocuğunuzun emniyetinin en yüksek seviyede olmasını garantilemek amacıyla,oto güvenlik koltuğu minimum 15 aylığa kadar kadar sürüş yönünün tersine doğru bakarak kullanılmalıdır. Bébé Confort, koltuğun mümkün olduğunca uzun süre ve gösterilen limite kadar (87 cm) sürüş yönünün tersine bakacak pozisyonunda kullanılmasını tavsiye eder. Bu, çocuğun bu yaşta hala son derece hassas olan kafasının ve boynunun çok daha iyi korunmasına olanak sağlar.

AR

يجب استعمال المقعد في الوضعية المواجهة للخلف حتى بلوغ عمر الـ 15 شهرا على الأقل أو طول 87 سنتيمترا لضمان تأمين سلامة مثلى لطفلك. ينصحك Bébé Confort باستعمال المقعد في الوضعية المواجهة للخلف لأطول وقت ممكن و حتى بلوغ الحد المذكور (87 سنتيمتر). يسمح هذا الإجراء بتحسين حماية رأس و رقبة الطفل، التي تكون عرضة للكسر في هذا السن، بشكل كبير.



- EN Rearward facing position
- FR Position dos route
- ES Posición en el sentido contrario a la marcha
- IT In senso contrario di marcia
- PT Posição voltada para a retaguarda
- RU Положение лицом назад
- TR Sürüş yönünün tersine dönük konum
- AR موقف تواجه المؤخرة



www.bebeconfort.com



61-87 cm

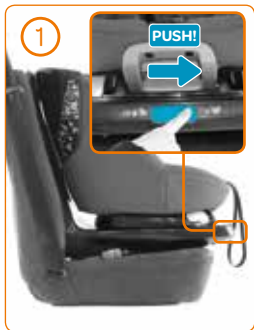





- EN Forward facing position
- FR Position face route
- ES Posición en el sentido de la marcha
- IT In senso di marcia
- PT Posição voltada para a frente
- RU Положение лицом вперед
- TR Sürüş yönüne dönük konum
- AR تواجه الأمام موقف



www.bebeconfort.com



76-105 cm



>15 m

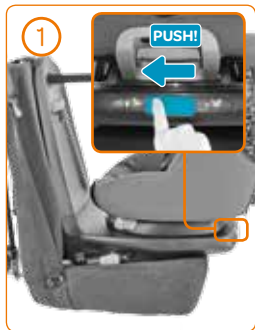

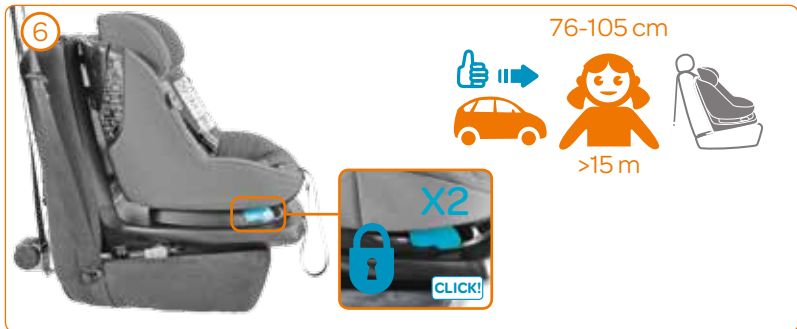
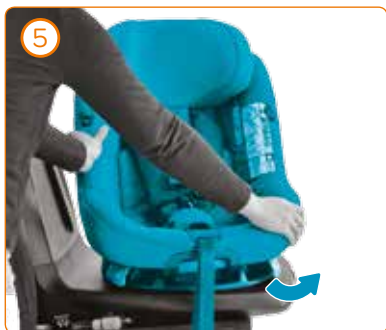



- EN Child installation
- FR Installation de l'enfant
- ES Instalación del niño
- IT Accomodare il bambino
- PT Instalação da criança
- RU Размещение ребенка
- TR Çocuğun bağlanması
- AR تثبيت الطفل



www.bebeconfort.com

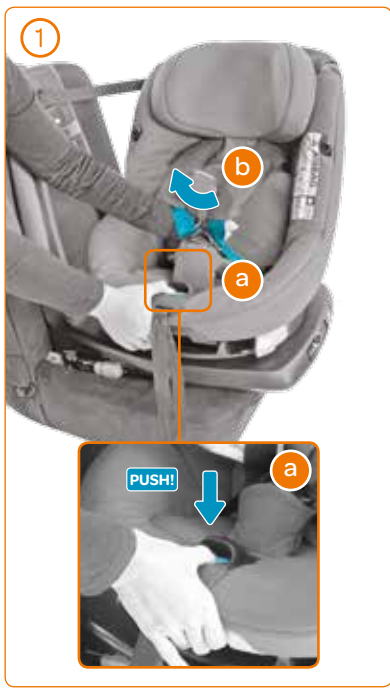



2





76-105 cm



>15 m



61-87 cm



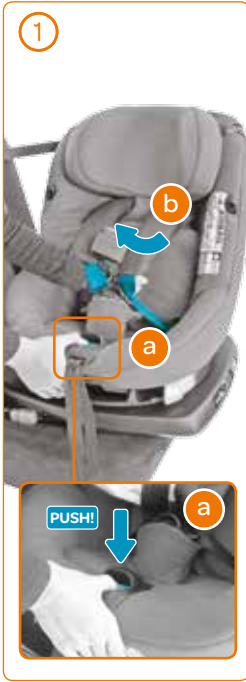

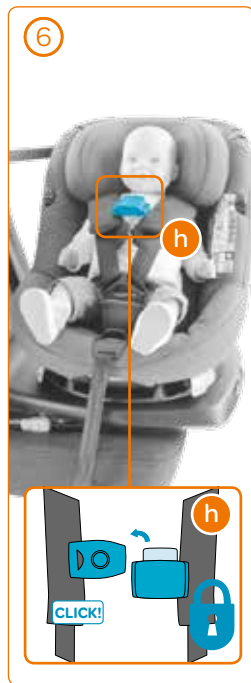
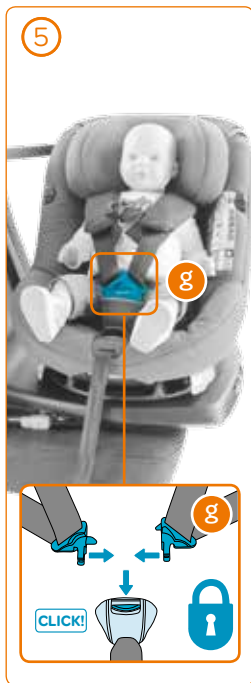
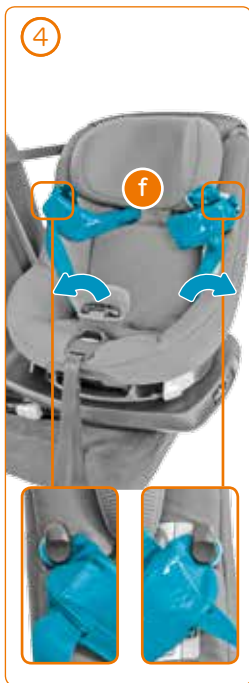



7



✗ NO

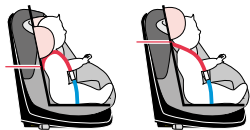

✓ OK

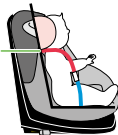



8

61-87 cm



9

76-105 cm





10



61-87 cm



76-105 cm



>15 m





EN Ready to go

FR Prêt à partir

ES Listo para ir

IT Si parte

PT Pronto para viajar

RU Готов к поездке

TR Gitmeye hazır

AR جاهز للذهاب



www.bebeconfort.com



61-87 cm



TOP TETHER

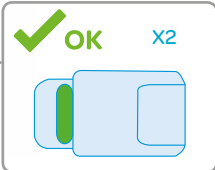



76-105 cm



>15m



TOP TETHER

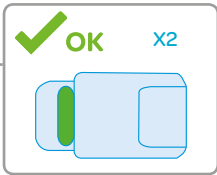

X2

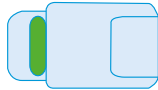



- EN Accessories sold separately
- FR Accessoires vendus séparément
- ES Accesorios que se venden por separado
- IT Accessori venduti separatamente
- PT Acessórios vendidos separadamente
- RU Аксессуары продаются отдельно
- TR Aksesuarlar ayrı satılır
- AR الملحقات المباعة بشكل منفصل



www.bebeconfort.com







EN Washing

FR Lavage

ES Lavado

IT Lavaggio

PT Lavagem

RU Чистка

TR Yıkama

AR غسل



www.bebeconfort.com





①





2

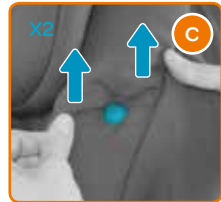







3

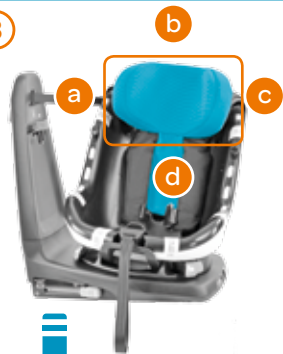



4





5

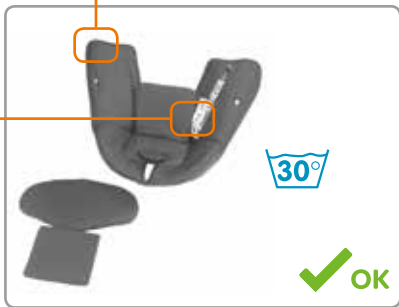



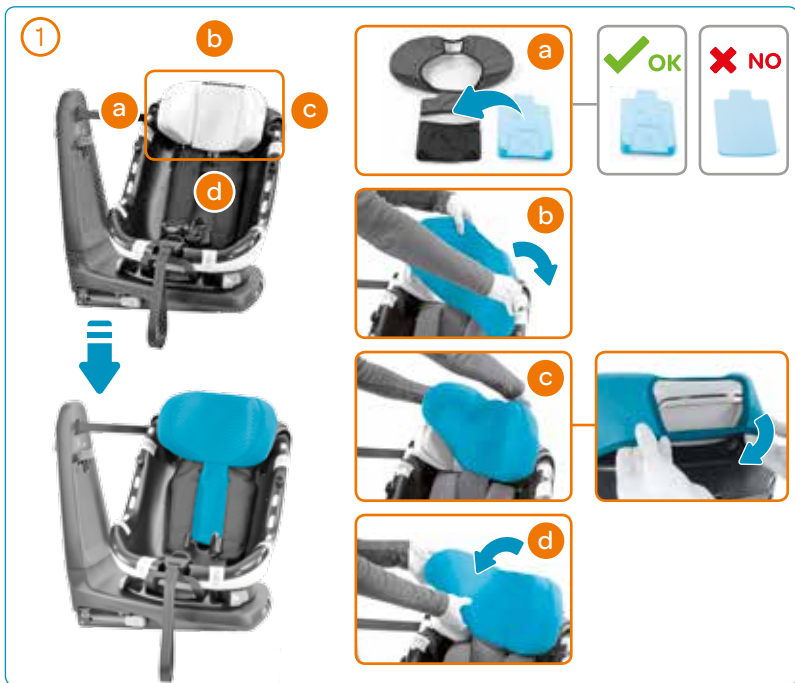



2

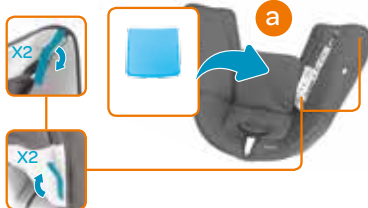
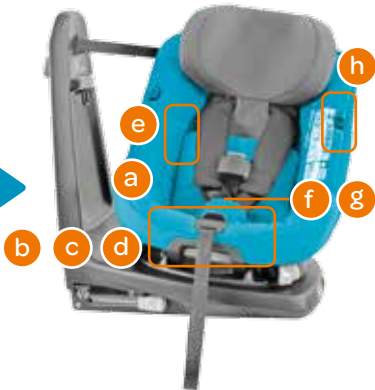







3



A - Adjustable headrest
B - Seat Cover
C - Shoulder pads hooks
D - 5-point Harness
E - Shoulder pads with integrated Airbag
F - Shoulder connector
G - Harness buckle
H - Harness adjuster button
I - Harness adjuster strap
J - Recline handle
K - Rotation handle (right & left)
L - Rearward facing/Forward facing selector button
M - ISOFIX clips activation handle
N - ISOFIX connectors
O - Headrest adjustment handle
P - TOP TETHER tensioning indicator
Q - TOP TETHER tensioning adjuster
R - TOP TETHER
S - TOP TETHER hook
T - TOP TETHER storage
U - Instruction leaflet storage
V - Automatic safety belt
W - Carrying

WARNING:

- Install the AxissFix Air in a rearward-facing position when your child is from 61 up to 87 cm in length.
- You may install the AxissFix Air in a forward-facing position when your child is from 76 up to 105 cm in length (older than 15 months). The maximum occupant mass for which the carseat is intended is 19 kg.

- The shoulder pad connector component has a magnetic closure system that is not compatible with a pacemaker.
- The good operation of the airbag system is monitored by an electronic device. Whenever the AxissFix Air seat is connected to the ISOFIX anchors the system is operational.
- The deployment of the airbag occurs in a fraction of a second, at very high speed, to ensure optimal protection in the event of an accident. A non-toxic cold vapour can be released when the airbag is deployed. This is a normal phenomenon that does not create a risk of burning to the occupant or other passengers of the vehicle.
- Airbag system non-deployment criteria:
 - Isofix anchorages unlocked
 - Frontal impact with low deceleration
 - Overturning
- The car seat can not be transported by airplane.
- The airbag contains specific components and should therefore be considered as special waste. At the end of life the car seat must be returned to DOREL after sales.



- Never unscrew the gas cartridge.
- The airbag system is self-contained and requires no maintenance and no intervention. It has a lifetime of about 10 years.



Care

Fabric:

- The shoulder pads are not removable but can be washed with a damp cloth. If the cover needs to be replaced at any time, only use official Bébé Confort cover because it constitutes an integral part of the restraint performance.
- Before cleaning check the label sewn into the various parts of the fabric, you will find the washing symbols indicating the method of washing each item.
- Keep the car seat clean. Do not use lubricants or aggressive cleaning agents.

Shell:

- Clean the shell using a damp cloth.

A - Têteière
B - Housse
C - Accroches fourreaux
D - Harnais 5 points
E - Fourreaux avec Airbag intégré
F - Connecteur de fourreau-bretelle
G - Boucle de harnais
H - Bouton d'ajusteur de harnais
I - Sangle d'ajusteur de harnais
J - Manette d'inclinaison
K - Poignée de rotation (droite et gauche)
L - Bouton sélecteur dos route / face route
M - Manette d'actionnement des pinces ISOFIX
N - Pincettes pour ancrage ISOFIX
O - Poignée ajustement hauteur têteière
P - Indicateur visuel de tensionneur de la TOP TETHER
Q - Ajusteur de tension TOP TETHER
R - TOP TETHER
S - Crochet TOP TETHER
T - Rangement TOP TETHER
U - Compartiment de rangement de la notice
V - Sangle automatique de sécurité
W - Transport

AVERTISSEMENT :

- Installez l'AxissFix Air dos à la route lorsque votre enfant mesure entre 61 et 87 cm.
- Vous pouvez installer l'AxissFix Air dans le sens de la conduite quand votre enfant mesure entre 76 et 105 cm (ou a plus de 15 mois). La masse maximale pour lequel le siège est conçu est 19 kg.
- Le composant connecteur de fourreau-bretelle comporte un système de fermeture magnétique

non compatible avec le port d'un pacemaker.

• Le bon fonctionnement du système d'airbag est surveillé par un dispositif électronique. Chaque fois que le siège AxissFix Air est connecté aux ancrages ISOFIX le système est opérationnel.

• Le déploiement de l'airbag se produit en quelques fractions de seconde, à très grande vitesse, afin de garantir une protection optimale en cas d'accident. Un nuage froid non toxique peut être libéré lors du déploiement de l'airbag. Ce phénomène tout à fait normal n'engendre pas de risque de brûlure pour son occupant ni pour les autres passagers du véhicule.

• Cas de non déclenchement du système d'airbag :

- Pincettes Isofix non verrouillées

- Collision frontale avec faible vitesse

- Tonneau

• Le siège auto ne peut pas être transporté en avion.

• L'airbag contient des composants spécifiques, par conséquent, il doit être considéré comme un déchet spécial. En fin de vie le siège auto doit être retourné au service après-vente DOREL.



- Ne jamais dévisser la bouteille de gaz.
- Le système airbag est autonome et ne nécessite pas d'entretien et aucune intervention. Il a une durée de vie de l'ordre de 10 ans.

Entretien

Confection:

- Les fourreaux ne peuvent pas être enlevés mais peuvent être nettoyés à l'aide d'un chiffon humide. La housse peut être enlevée pour le lavage. Si la housse doit être remplacée à quelque moment que ce soit, utilisez uniquement la housse officielle Bébé Confort car elle constitue une partie intégrante de la performance de la retenue de l'enfant.
- Avant nettoyage consulter l'étiquette de composition du textile cousue sur les différents éléments de la confection, vous y retrouverez les symboles de lavage propre à l'élément à laver.
- Conserver le siège auto propre. N'utilisez ni lubrifiant ni agent de nettoyage agressif.

Coque:

- Nettoyez la coque à l'aide d'un chiffon humide.

A - Cojín cuello
B - Funda
C - Enganches de las almohadillas para el hombro
D - Arnés de 5 puntos
E - Protege arneses con Airbag incorporado
F - Conector para los hombros
G - Cierre del arnés
H - Botón de ajuste del arnés
I - Cinta de ajuste del arnés
J - Palanca de inclinación
K - Palanca de rotación (derecha e izquierda)
L - Botón de selección del sentido contrario a la marcha / Sentido de la marcha
M - Palanca de accionamiento de las pinzas ISOFIX
N - Pinzas para anclajes ISOFIX
O - Palanca de ajuste del reposacabezas
P - Indicador de tensión de TOP TETHER
Q - Ajuste de tensión de TOP TETHER
R - TOP TETHER
S - Enganche de TOP TETHER
T - Compartimento TOP TETHER
U - Compartimento para el manual
V - Correa de seguridad automática
W - Transporte

ADVERTENCIA:

- Instale la silla de auto AxisFix Air en el sentido contrario a la marcha si la estatura de su hijo es de 61 a 87 cm.
- Deberá instalar la silla de auto en el sentido de la marcha cuando la estatura de su hijo sea de entre 76 y 105 cm (mayor de 15 meses). El peso máximo para el que se ha concebido el asiento es de 19 kg.

- El componente conector del protege arneses tiene un sistema de cierre magnético no compatible con un marcapasos.
- El correcto funcionamiento del sistema de airbags es monitorizado por un dispositivo electrónico. Mientras la AxisFix Air esté conectada a los anclajes ISOFIX, el sistema estará funcionando.
- El despliegue de los airbags se produce en una fracción de segundo, a muy alta velocidad, para asegurar una óptima protección en caso de accidente. Un vapor frío no tóxico puede desprenderse al desplegarse el airbag. Es un fenómeno normal que no ocasiona ningún riesgo al ocupante u otros pasajeros del vehículo.
- Criterios para que el sistema de airbags no se despliegue:
 - Anclajes ISOFIX no conectados
 - Impacto frontal con una baja desaceleración
 - Volcado
- La silla de auto no puede transportarse por avión
- Los airbags contienen componentes específicos y debería desecharse como un residuo especial. Después de su vida útil debe ser retornada al servicio de posventa de Dorel.



- No desatornillar el cartucho de gas.
- El sistema de airbags es autocontenido y no requiere mantenimiento ni intervención. Tiene una vida útil de aproximadamente 10 años.

Mantenimiento

Textil:

- Los proteges arneses no se pueden retirar pero pueden lavarse con un paño húmedo. La vestidura puedes retirarse para su lavado. Si fuese necesario cambiar la funda, hágalo únicamente por otra funda Bébé Confort oficial, dado que constituye una parte integrante de la seguridad.
- Antes de lavarlo, consultar la etiqueta de composición textil cosida a la vestidura dónde se encuentran las instrucciones y los símbolos para lavar correctamente la confección.
- Mantenga el asiento limpio. No use lubricantes ni productos de limpieza agresivos.

Carcasa:

- Limpiar la carcasa con un trapo húmedo.

A - Poggiatesta
B - Rivestimento
C - Ganci per cintura
D - Cintura a 5 punti
E - Copricinture con Airbag integrato
F - Connettore cinture
G - Fibbia
H - Pulsante per il rilascio della cintura
I - Cinghia regolazione cintura
J - Dispositivo per la reclinazione
K - Dispositivo di rotazione (destra e sinistra)
L - Tasto selettore senso di rotazione
M - Levetta per azionare le pinze ISOFIX
N - Pinze per fissaggio ISOFIX
O - Maniglia regolazione poggiatesta
P - Indicatore di tensione TOP TETHER
Q - Regolatore di tensione TOP TETHER
R - TOP TETHER
S - Gancio TOP TETHER
T - Spazio per riporre TOP TETHER
U - Tasca per conservare le istruzioni
V - Cinghia di sicurezza automatica
W - Trasporto

AVVERTENZA:

- Installare AxissFix Air in posizione contraria al senso di marcia quando il bambino è alto 61-87 cm.
- E' possibile installare AxissFix Air rivolto in senso di marcia a partire da quando il bambino è alto 76 cm fino a 105 cm (o a partire da 15 mesi). Il peso massimo per cui il seggiolino è ideato è di 19 kg.
- Il connettore dei copricintura ha un sistema

di chiusura magnetica che non può essere utilizzato con un pacemaker.

- Il buon funzionamento del sistema di airbag è controllato da un dispositivo elettronico. Ogni volta che il seggiolino AxissFix Air è fissato agli ancoraggi ISOFIX il sistema è operativo.
- L'apertura dell'airbag avviene in poche frazioni di secondo, ad alta velocità, in modo da garantire una protezione ottimale in caso di incidente. Una nube di vapore freddo non tossico potrebbe essere rilasciata durante l'apertura dell'airbag. Si tratta di un fenomeno del tutto normale che non comporta rischi di bruciatura per l'occupante o per gli altri passeggeri nel veicolo.
- Casi in cui il sistema di airbag non sarà attivato:
 - Ancoraggi Isofix non fissati
 - Impatto frontale a bassa velocità
 - Ribaltamento
- Il seggiolino auto non può essere trasportato in aereo.
- L'airbag contiene componenti specifiche e deve quindi essere considerato come un rifiuto speciale. A fine vita il seggiolino deve essere restituito al servizio post vendita di DOREL.



- Non svitare mai la cartuccia di gas.
- Il sistema di airbag è autonomo e non necessita di manutenzioni o interventi. Esso ha una durata di vita di circa 10 anni.



Lavaggio

Rivestimento:

- I copricinture non sono rimovibili, ma possono essere lavati con un panno umido. La fodera può essere rimossa per il lavaggio. Se la copertura deve essere sostituita, usare solo il rivestimento ufficiale Bébé Confort perché costituisce una parte integrante del sistema di bloccaggio.
- Prima del lavaggio, consultare l'etichetta di composizione del tessuto cucita sulla confezione, per verificare i simboli di lavaggio.
- Tenere il seggiolino auto pulito. Non usare lubrificanti o agenti detergenti aggressivi.

Scocca:

- Pulire la scocca con un panno umido.

A - Apoio de cabeça ajustável
B - Forra
C - Engates das protecções dos ombros
D - Arnês de 5 pontos
E - Protecções do arnês com airbag integrado
F - Conector do sistema airbag nas protecções do arnês
G - Fivela do cinto
H - Botão de regulação do cinto
I - Correia de regulação do cinto
J - Alavanca de inclinação
K - Punho de rotação (direita e esquerda)
L - Botão de selecção bebé virado para trás / Para a frente
M - Alavanca de accionamento dos conetores ISOFIX
N - Conetores para fixação ISOFIX
O - Pega de regulação do apoio de cabeça
P - Indicador de tensão TOP TETHER
Q - Regulador de tensão TOP TETHER
R - TOP TETHER
S - Gancho TOP TETHER
T - Bolso de arrumação TOP TETHER
U - Compartimento de arrumação do manual
V - Correia de segurança automática
W - Transporte

ATENÇÃO:

Instalar a AxissFix Air na posição de costas para a estrada quando a criança tiver entre 61 e 87 cm de comprimento.

• Pode instalar a AxissFix Air na posição de frente para a estrada quando a criança tiver entre 76 e 105 cm de comprimento (mais

de 15 meses). O peso máximo para o qual a cadeira é concebida são 19 kg.

• O componente que faz a conexão com as protecções do arnês possui um sistema de fecho magnético que não é compatível com um pacemaker.
• O bom funcionamento do sistema do airbag é motorizado por dispositivo eletrónico. O sistema fica operacional sempre que o assento da AxissFix Air estiver conectado com os pontos âncora ISOFIX.

• A explosão do airbag ocorre numa fração de segundos, a uma grande velocidade, para garantir protecção extrema em caso de acidente. Poderá ocorrer a libertação de um gás frio, não tóxico, aquando da explosão do airbag. Este é um fenómeno normal que não cria risco de queimaduras ao ocupante ou aos outros passageiros do veículo.

• O sistema de airbag não activa caso:

- As pinças ISOFIX não estejam fixas ao chassis do automóvel.

- Colisão frontal a baixa velocidade

- Capotamento

• Esta cadeira-auto não pode ser transportada no avião

• O airbag contém componentes específicos e, por isso, deve ser considerado como um resíduo especial. No final de vida do artigo, a cadeira-auto deverá ser devolvida ao Serviço de Após Venda da DOREL.



- Nunca desatarraxe a botija de gás.
- O sistema de airbag é autónomo e não requer manutenção e intervenção. Possui um tempo de vida de 10 anos.

Limpeza:

Confecção:

- As proteções do arnês não são amovíveis mas podem ser lavadas com um pano húmido. A forra pode ser retirada para lavar. Se a cobertura necessitar de ser substituída, usar somente coberturas originais da Bébé Confort uma vez que as mesmas constituem uma peça integrante do desempenho controlado.
- Antes da lavagem, consulte a etiqueta da composição do tecido onde encontrará os símbolos de lavagem adequados:
- Manter a cadeira-auto limpa. Não usar lubrificantes ou agentes de limpeza agressivos.

Base:

- Limpar a base com um pano húmido.

A - Регулируемый подголовник
B - Обивка
C - Крючки подплечников
D - 5-точковые ремни безопасности
E - Плечевые накладки со встроенной подушкой безопасности
F - Плечевой соединитель
G - Кнопка регулировки ремней
H - Регулирующая лямка ремней
I - Ручка управления наклоном спинки
J - Ручка управления наклоном спинки
K - Поворотная рукоятка (правая и левая)
L - Ручка переключения между положениями лицом назад / вперед
M - Рычаг активации зажимов ISOFIX
N - Разъемы ISOFIX
O - Ручка регулировки подголовника
P - Индикатор натяжения ремня TOP TETHER
Q - Регулятор натяжения TOP TETHER
R - Ремень TOP TETHER
S - Крюк ремня TOP TETHER
T - Карман для хранения ремня TOP TETHER
U - Отделение для хранения инструкции
V - Автоматический ремень безопасности
W - Ручка

ВАЖНО:

- Устанавливайте кресло AxisFix Air в положении лицом назад, если рост вашего ребенка составляет 61–87 см.
- Вы можете установить кресло AxisFix Air в положение лицом вперед, после достижения

вашим ребенком возраста 15 месяцев и более и роста от 76 до 105 см. Максимальная масса пассажира, на которую рассчитано данное автокресло, составляет 19 кг.

- Один из компонентов наплечника ремня безопасности оснащен магнитной системой, которая не совместима с кардиостимулятором.
- Коректна робота системи подушок безпеки контролюється електронним пристроєм. Коли автокрісло AxisFix Air встановлюється на кріплення ISOFIX, система включається.
- Розгортання подушки безпеки відбувається миттєво, з дуже великою швидкістю, для забезпечення оптимального захисту в разі аварії. Нетоксичний холодний пар може бути випущений при спрацьовуванні подушки безпеки. Це нормальне явище, яке не створює пожежної небезпеки для пасажирів в автокріслі або інших пасажирів транспортного засобу.
- Випадки, коли система подушок безпеки не спрацьовує:
 - Кріплення Isofix не замкнуті
 - Фронтальний удар з невеликим негативним прискоренням
 - Переворот автомобіля
- Автокрісло не можна перевозити в літаку.
- Подушка безпеки містить спеціальні компоненти, і тому у сенсі утилізації вона відноситься до спеціальних відходів. Після закінчення терміну служби автокрісло слід повернути в службу післяпродажного обслуговування DOREL.



- Ніколи не відкручуйте газовий балон.
- Система подушок безпеки є автономною, вона не вимагає обслуговування або втручання. Термін її служби складає близько 10 років.

Чистка/уход

Ткань обивки:

- Подплечники не снимаются, но их можно мыть влажной тканью. Чехол сидения можно снять для стирки. Для замены обивки необходимо использовать только фирменные изделия Bébé Confort, поскольку они являются неотъемлемой частью, обеспечивающей функциональные характеристики всего кресла.
- Перед чисткой найдите шитый ярлык, на нем вы найдете пиктограммы по уходу, указывающие методы чистки и мытья всех частей кресла.
- Сохраняйте автокресло в чистоте. Не используйте смазку или агрессивные моющие средства.

Корпус:

- Чистите корпус влажной тканью.

- A - Ayarlanabilir Baş desteği
- B - Kılıf
- C - Omuz yastığı kancaları
- D - 5 nokta emniyet kemeri
- E - Hava yastığı içeren omuz pedleri
- F - Omuz bağlantısı
- G - Kemer donanımı tokası
- H - Kemer donanımı ayar düğmesi
- I - Kemer donanımı ayar kayışı
- J - Geriye yatırma kolu
- K - Çevirme kolu (sağ ve sol)
- L - Geriye bakma / İleriye bakma seçim düğmesi
- M - ISOFIX klips etkinleştirme kolu
- N - ISOFIX bağlantıları
- O - Kafalık ayar kolu
- P - Üst Bağlantı Kemer gerginlik göstergesi
- Q - Üst Bağlantı Kemer gerginlik ayarlayıcı
- R - Üst Bağlantı Kemer
- S - Üst Bağlantı Kemer kancası
- T - Üst Bağlantı Kemer saklama bölümü
- U - Talimat kitapçığı cebi
- V - Otomatik emniyet kayışı
- W - Taşıma

UYARI:

- Çocukunuzun boyu 61 ila 87 cm arasında olduğunda, AxissFix Air'i sürüş yönünün tersine bakar konuma yerleştirin.
- Çocukunuzun boyu 76 ila 105 cm arasında olduğunda (15 aylıktan daha büyük), AxissFix Air'i sürüş yönüne bakar konuma yerleştirin. Araç koltuğu maksimum 19 kg'lık bir ağırlığa uygun olarak tasarlanmıştır.
- Omuz pedi bağlantısı içeriğinde manyetik

kapanma sistemi bulunduğundan, kalp pili bulunan çocuklar için kullanımı uygun değildir.

- Hava yastığı sisteminin düzgün çalışıp çalışmadığı bir elektronik cihaz tarafından kontrol edilir. AxissFix Air koltuğu ISOFIX bağlantılarına bağlı olduğunda sistem düzgün çalışıyor demektir.
- Bir kaza durumunda en iyi korumayı sağlamak amacıyla hava yastığının açılması bir saniyeden daha kısa sürede, çok hızlı bir şekilde gerçekleşir. Hava yastığı açıldığında zehirli olmayan soğuk bir buhar çıkabilir. Bu durum kullanıcı veya diğer yolcular açısından yanma riski oluşturmayan normal bir olgudur.
- Hava yastığı sisteminin açılmama kriterleri:
 - Isifix bağlantıları kilitleti değil
 - Düşük hızda önden darbe
 - Devrilme
- Araç koltuğu uçak ile taşınamaz.
- Hava yastığı bazı belirli bileşenler içerdiğinden özel atık olarak değerlendirilmelidir. Kullanım ömrünün sonunda araba koltuğu DOREL satış sonrası hizmetlere iade edilmelidir.



- Asla gaz kartuşunu sökmeyin.
- Hava yastığı sistemi kendi kendine yeterlidir ve herhangi bir bakım ve müdahale gerektirmez. Yaklaşık 10 yıllık bir kullanım ömrüne sahiptir.

BAKIM

Kumaş:

- Omuz pedleri ayrılabilir değildir, ancak nemli bir bez ile temizlenebilir. Kılıf üründen ayrılarak yıkanabilir. Kılıfın herhangi bir zamanda değiştirilmesi gerekirse, çocuk emniyet sistemi performansının entegre bir parçası olduğundan sadece resmi kılıfı kullanın.
- Temizlemeden önce kumaşa dikilen etiketi kontrol edin, her bir ürünün nasıl yıkanacağını gösteren yıkama işaretlerini göreceksiniz.
- Araç koltuğunu temiz tutun. Yağlayıcılar veya aşındırıcı temizlik maddeleri kullanmayın.

Dış kısım:

- Dış kısmı nemli bir bez kullanarak temizleyin.

- A - ممسند الرأس
- B - الكسوة
- C - حزام بخمس نقاط
- D - وسادات كنف قابلة للإزالة
- E - حشوة كنف مزودة بوسادة هوائية مدمجة
- F - وصلة الكنف
- G - مشبك الحزام
- H - زر تعديل الحزام
- I - طوق تعديل الحزام
- J - مقبض الإمالة
- K - مقبض التدوير (يمين و يسار)
- L - زر اختيار الوضعية المواجهة للخلف / المواجهة للأمام
- M - مقبض تشغيل مشابك ISOFIX
- N - واصلات ISOFIX
- O - مقبض تعديل مسند الرأس
- P - مؤشر شدّ TOP TETHER
- Q - مُجَل شدّ حزام TOP TETHER
- R - حيز تخزين حزام TOP TETHER
- S - مشبك TOP TETHER
- T - موضع تخزين TOP TETHER
- U - موضع تخزين نشرة التعليمات
- V - حزام الأمان الأوتوماتيكي
- W - الحامل

تحذير:

- ثبت الـ AxissFix Air في وضعية مواجهة للخلف عندما يكون طول طفلك ما بين ٦١ و ٨٧ سنتيمترا.
- يمكنك تثبيت الـ AxissFix Air في وضعية مواجهة للأمام عندما يتراوح طول ابنك بين ٧٦ و ١٠٥ سنتيمتر (أكبر من ١٥ شهرا). كتلة الراكب القصوى التي صنمّم مقعد السيارة لأجلها هي ١٩ كلغ.
- يحتوي مكوّن واصل الكنف على نظام إغلاق مغناطيسي

- غير متوافق مع جهاز تنظيم ضربات القلب.
- الإشتغال الجيد لنظام الوسادة الهوائية خاضع لمراقبة جهاز الكتروني. كلما اتصل مقعد الـ AxissFix Air بمثبتات الـ ISOFIX صار النظام جاهزا للعمل.
- انفتاح الوسادة الهوائية يحدث في جزء من الثانية، بسرعة فائقة جدًا، لضمان حماية مثالية في حالة وقوع حادث. من الممكن تسرب بخار بارد و غير سام عند انفتاح الوسادة الهوائية. هذه ظاهرة عادية لا تشكل أي خطر احتراق للسائق أو باقي ركاب السيارة.
- معابيير عدم انفتاح نظام الوسادة الهوائية:
- مراسي Isofix غير مقلّة
- تأثير أمامي مع تباطؤ منخفض
- انقلاب
- لا يمكن نقل مقعد السيارة عبر الطائرة.
- تحتوي الوسادة الهوائية على مكونات خاصة لهذا وجب اعتبارها نفايات خاصة. عند انتهاء صلاحية مقعد السيارة يجب إرجاعه إلى DOREL ما بعد البيع.



- لا تفك خرطوشة الغاز أبدا.
- نظام الوسادة الهوائية مستقل و لا يحتاج أيّ صيانة أو تدخّل. متوسط عمره حوالي ١٠ سنوات.

رعاية

القمّاش:

- لا يمكن نزع حشوة الكنف ولكن يمكن غسلها بقطعة قماش مبلّلة. يمكن نزع الغطاء لغسله. إذا كان الغطاء في حاجة لأن يُستبدل في أيّ وقت، استعمل غطاء الرسمي فقط لأنه يشكل جزءا رئيسيا من أداء مساند الرأس.

- قبل الغسل، اطلع على الملصقة المخططة بالقماش للاطلاع على رموز الغسل التي تشير إلى الطريقة المناسبة لكل قطعة.
- حافظ على مقعد السيارة نظيفاً. لا تستعمل زيوت التشحيم أو مواد التنظيف العدوانية.

الهيكل الخارجي:

- قم بتنظيف الهيكل الخارجي باستخدام قطعة قماش رطبة.